

# ECOUSTIC® BOND INSTALLATION + CARE

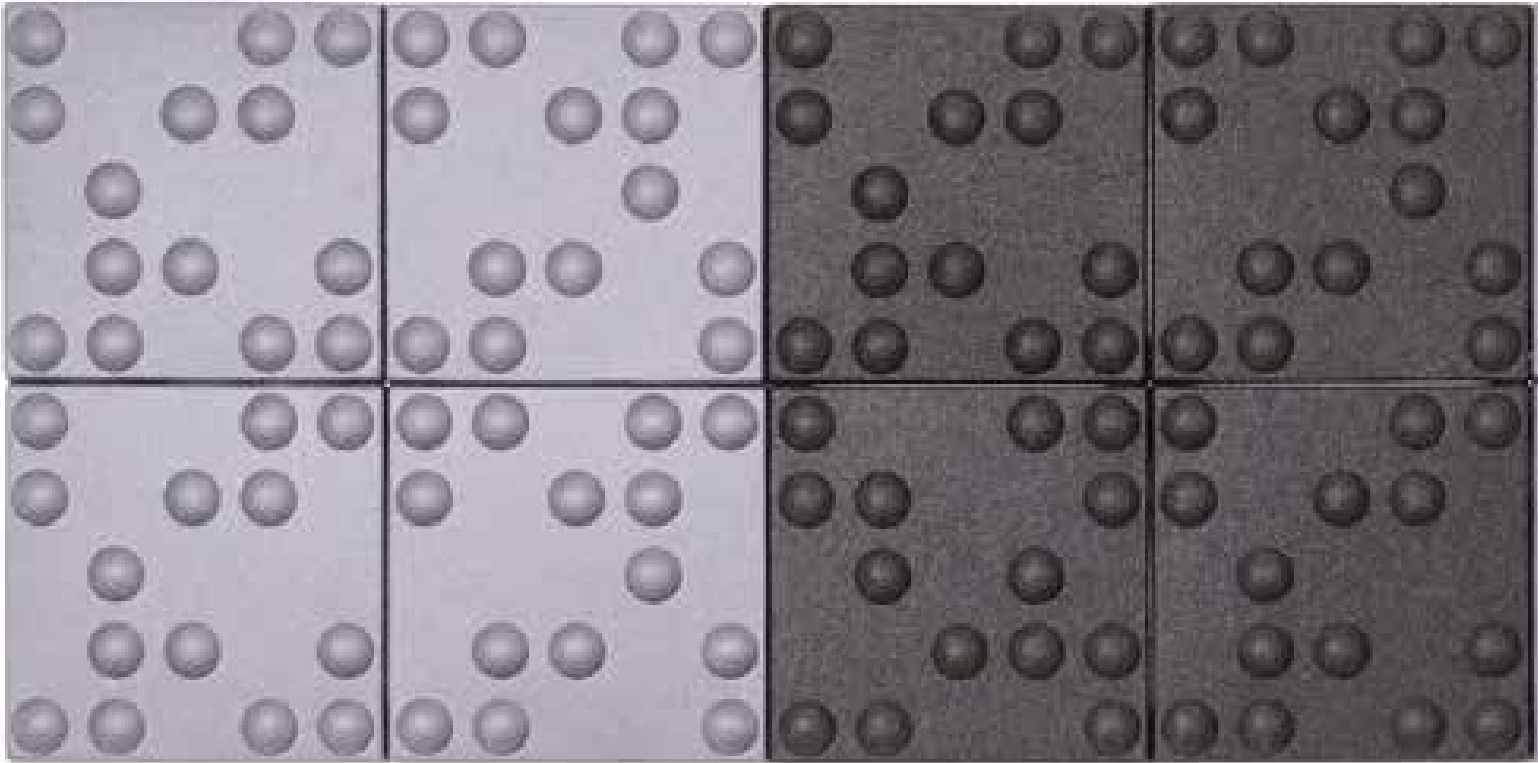

unika vaev  
INSTYLE

# ECOUSTIC® BOND INSTALLATION

## ASSEMBLY INSTRUCTIONS

### Supplied

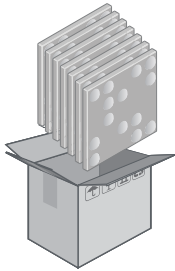

8x ecooustic® Bond tiles  
Sold in boxes of 8 per color  
9x 4-way joiner clips (+1 spare)  
Clip template  
Installation instructions

### Source



Flat-head c/sunk Power drill  
1" (25mm) 10g  
[ 4-8 per tile ]

### Essential

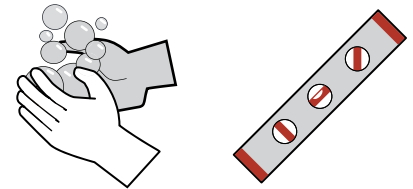

Clean hands  
Handle with care  
during installation

Spirit level

## INSTALLATION

### Step 1

In most situations it is best to measure up from the floor and mark a straight line from the base of the area, this line is your datum. On the datum, mark your starting position in bottom left corner.

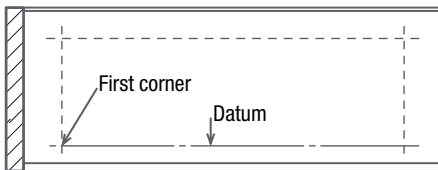

### Step 2

Using fixings suitable for your substrate, fix the first corner in place.  
*Note: Always use a mechanical means of fixing*

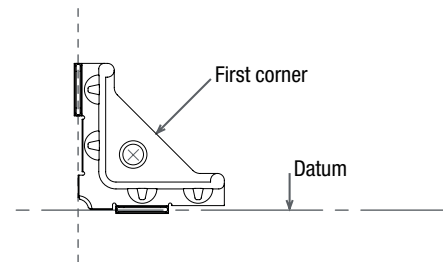

### Step 3

Use the supplied template to fix the next 3 clips in place.

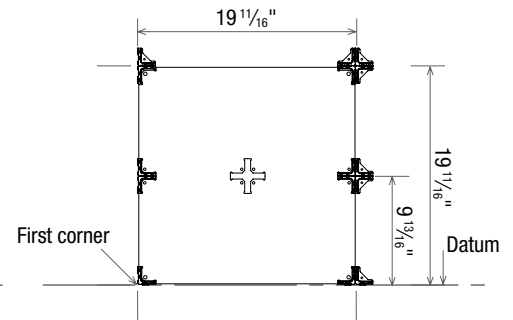

### Step 4

Using the template work your way up the wall in columns. Finish the top with corner clips on corners + edge clips on straight joins.

*Note: Never use the tiles to measure spacing.*

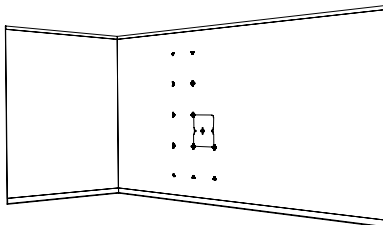

### Step 5

Once you have two columns up, double check your spacing by installing the first column of tiles. Always stay one column ahead of the installed tiles so the tiles don't interfere with the spacing.

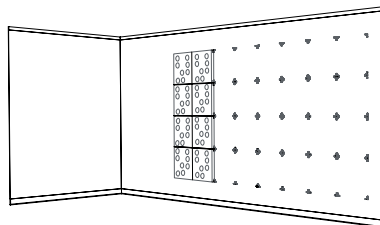

### Step 6

Install the rest of your clips and put up the tiles to finish.  
For ceiling installations, we recommend the use of glue for additional fixing.

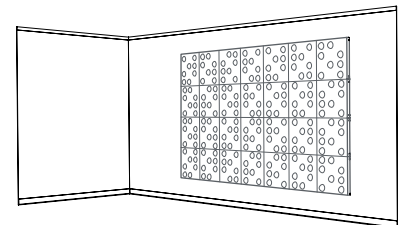

# ECOUSTIC® BOND CARE

## Please Note

- Care must be taken when cleaning as these instructions apply to the fabric face only and the possible effect of the cleaning regime on underlying bases and wall surface must be considered.
- For these reasons it is suggested to spot clean only and that it may be carried out by a professional cleaner.

## Regular Care

- Protect from direct heat and sunlight.
- To prevent dust build up, lightly dust with a soft cloth or vacuum with a soft brush attachment.

## Cleaning

- Professional cleaning is always recommended.
- Always test any cleaning products on an inconspicuous area prior to commencing cleaning.
- Blot any excess spills from the material with a dry clean sponge or cloth.
- Treat all stains as soon as possible.
- Most marks can be spot cleaned by lightly wetting the affected area with a mild detergent and warm water solution.
- Do not saturate the tile.
- Do not scrub or abrade the tile surface as this will affect the surface finish.
- Once the stain or mark has been loosened, blot the excess solution out with a dry clean sponge or cloth.
- Sponge afterwards with clean warm water and dry any excess solution out with a dry clean sponge or cloth.
- The fabric may also be spot cleaned with dry cleaning fluid. Lightly sponge a small amount of dry cleaning fluid and blot.
- Dry away from direct heat or sunlight.
- Do not use carpet shampoo.